

# Classic Scroll

~~MADE TO MEASURE SERVICE IS NOT AVAILABLE ON THE CLASSIC DESIGN.~~

## CLASSIC SPECIFICATIONS

solid steel construction  
 Frames 20mm x 6mm for Singles and Bow Tops  
 Frames 25mm x 6mm for Doubles  
 Infill bars 10mm diameter  
 Scrollwork 10mm x 3mm  
 Standard is primed or powder coated black.  
 Optional zinc plated & black powder coated black.



Single

Classic Low Flat Single Gate FITTINGS INCLUDED			
CODE	FITS OPENING	FRAME HEIGHT	TOP OF SCROLLS
CS2	838mm (2'9")	812mm (32")	914mm (36")
CS3	914mm (3'0")	812mm (32")	914mm (36")
CS4	991mm (3'3")	812mm (32")	914mm (36")

Classic Single - Square Metal Post option  
 CODE SIZE STYLE  
 UPZP1 50mm Sq Flat Top, Pre-Drilled, Concrete-In  
 BP50X1400ZP Flat Top, Blank Post, Concrete-In  
 BP50X1400BZP Ball Top, Blank Post, Concrete-In



Bow Top

Classic Tall Bow Top Single Gate FITTINGS INCLUDED		
CODE	FITS OPENING	GATE HEIGHT
CB40	762mm (2'6")	1753mm (69")
CB41	838mm (2'9")	1791mm (70.5")
CB42	914mm (3'0")	1830mm (72")
CB43	991mm (3'3")	1867mm (73.5")
CB44	1067mm (3'6")	1905mm (75")

Classic Bow Top - Square Metal Post option  
 CODE SIZE STYLE  
 UPZP2 50mm Sq x 2100mm Flat Top, Pre-Drilled, Concrete-In  
 BP50X2350ZP Flat Top, Blank Post, Concrete-In  
 BP50X2350BZP Ball Top, Blank Post, Concrete-In



Low Bow

Classic Low Bow Top Single Gate FITTINGS INCLUDED		
CODE	FITS OPENING	GATE HEIGHT
CLB51	838mm (2'9")	1181mm (46.5")
CLB52	914mm (3'0")	1219mm (48")
CLB53	991mm (3'3")	1257mm (49.5")

Classic Low Bow - Square Metal Post option  
 CODE SIZE STYLE  
 UPZP1 50mm Sq Flat Top, Pre-Drilled, Concrete-In  
 BP50X1400ZP Flat Top, Blank Post, Concrete-In  
 BP50X1400BZP Ball Top, Blank Post, Concrete-In



Double

Classic Double Driveway Gate FITTINGS INCLUDED			
CODE	FITS OPENING	FRAME HEIGHT	TOP OF SCROLLS
CD10	2134mm (7'0")	812mm (32")	914mm (36")
CD13	2438mm (8'0")	812mm (32")	914mm (36")
CD16	2743mm (9'0")	812mm (32")	914mm (36")
CD19	3048mm (10'0")	812mm (32")	914mm (36")

Classic Double - Square Metal Post options  
 CODE STYLE  
 Fits: CD10-CD13  
 BP50X1400ZP Flat Top, Blank Post, Concrete-In  
 BP50X1400BZP Ball Top, Blank Post, Concrete-In  
 Fits: CD10-CD19  
 UPZP3 70mm Sq Flat Top, Pre-Drilled, Concrete-In  
 BP70X1400ZP Flat Top, Blank Post, Concrete-In  
 BP70X1400BZP Ball Top, Blank Post, Concrete-In



Railing

Classic Railing Panel FITTINGS INCLUDED		
CODE	FITS OPENING	RAILING HEIGHT
CL06	1830mm (6'0")	355mm (14")

Classic Railing - Square Metal Post options  
 BP50X500ZP Flat Top, Blank Post, Bolt Down  
 BP50X500BZP Ball Top, Blank Post, Bolt Down

**Optional improved finish available subject to stock availability:**  
 Electro Galvanised & Powder Coated for added rust resistance,  
 call the help line for the cost and the stock code.



# Regent Scroll



MADE TO MEASURE SERVICE IS NOT AVAILABLE ON THE REGENT DESIGN

## REGENT SPECIFICATIONS

Solid steel construction  
 Frames 20mm x 6mm for Singles and Bow Tops  
 Frames 25mm x 6mm for Doubles  
 Infill bars 10mm diameter  
 Scrollwork 10mm x 3mm  
 Standard is primed or powder coated black  
 Optional zinc plated & black powder coated black.



Single

**Regent low Single Gate** FITTINGS INCLUDED

CODE	FITS OPENING	FRAME HEIGHT	TOP OF SCROLLS
RS2	838mm (2'9")	812mm (32")	914mm (36")
RS3	914mm (3'0")	812mm (32")	914mm (36")
RS4	991mm (3'3")	812mm (32")	914mm (36")

Regent Single - Square Metal Post option

CODE	SIZE	STYLE
UPZP1	50mm Sq	Flat Top, Pre-Drilled, Concrete-In
BP50X1400		Flat Top, Blank Post, Concrete-In
BP50X1400B		Ball Top, Blank Post, Concrete-In

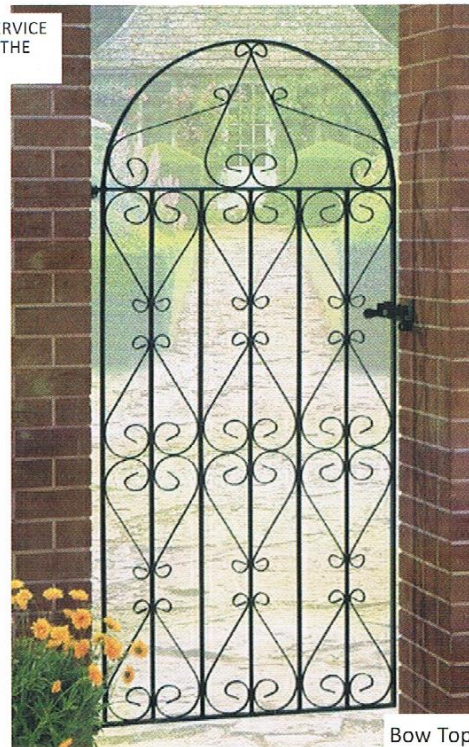

Bow Top

**Regent Tall Bow Top Single Gate** FITTINGS INCLUDED

CODE	FITS OPENING	GATE HEIGHT
RB40	762mm (2'6")	1753mm (69")
RB41	838mm (2'9")	1791mm (70.5")
RB42	914mm (3'0")	1830mm (72")
RB43	991mm (3'3")	1867mm (73.5")
RB44	1067mm (3'6")	1905mm (75")

Regent Bow Top - Square Metal Post option

CODE	SIZE	STYLE
UPZP2	50mm Sq x 2100mm	Flat Top, Pre-Drilled, Concrete-In
BP50X2350		Flat Top, Blank Post, Concrete-In
BP50X2350B		Ball Top, Blank Post, Concrete-In



Double

**Regent Double Driveway Gate** FITTINGS INCLUDED

CODE	FITS OPENING	FRAME HEIGHT	TOP OF SCROLLS
RD10	2134mm (7'0")	812mm (32")	914mm (36")
RD13	2438mm (8'0")	812mm (32")	914mm (36")
RD16	2743mm (9'0")	812mm (32")	914mm (36")
RD19	3048mm (10'0")	812mm (32")	914mm (36")

Regent Double - Square Metal Post options

CODE	SIZE	STYLE
Fits: RD10-RD13		
BP50X1400		Flat Top, Blank Post, Concrete-In
BP50X1400B		Ball Top, Blank Post, Concrete-In
Fits: RD10-RD19		
UPZP3	70mm Sq	Flat Top, Pre-Drilled, Concrete-In
BP70X1400		Flat Top, Blank Post, Concrete-In
BP70X1400B		Ball Top, Blank Post, Concrete-In



MADE TO MEASURE SERVICE IS NOT AVAILABLE ON THE REGENT DESIGN DUE TO FIXED SCROLL SIZE

**Optional improved finish available subject to stock availability:**  
 Electro Galvanised & Powder Coated for added rust resistance, call the help line for the cost and the stock code.

Railing



**Regent Railing Panel** FITTINGS INCLUDED

CODE	FITS OPENING	RAILING HEIGHT
RR06	1830mm (6'0")	395mm (15.5")

Regent Railing - Square Metal Post options

BP50X500	Flat Top, Blank Post, Bolt Down
BP50X500B	Ball Top, Blank Post, Bolt Down



# Stirling Scroll



MADE TO MEASURE SERVICE AVAILABLE ON STIRLING RANGE, GAPS BETWEEN SCROLL SECTIONS WILL VARY TO SUIT, SCROLL SECTION IS A FIXED SIZE.

## STIRLING SPECIFICATIONS

Solid steel construction  
 Frames - 25mm x 10mm  
 Infill bars 10mm diameter,  
 Scrollwork 10mm x 3mm  
 Infill bars 12mm diameter,  
 Standard is primed or powder coated black

**Optional improved finish available subject to stock availability:**

Electro Galvanised & Powder Coated for added rust resistance, call the help line for the cost and the stock code.



### Stirling Railing FITTINGS INCLUDED

CODE FITS OPENING RAILING HEIGHT  
**ST06** 1830mm (6'0") 403mm (15.9")

Stirling Railing - Square Metal Post options

**BP50X500ZP** Flat Top, Blank Post, Bolt Down  
**BP50X500BZP** Ball Top, Blank Post, Bolt Down



Stirling Single

### Stirling Low Single Gate FITTINGS INCLUDED

CODE	FITS OPENING	FRAME HEIGHT	TOP OF SCROLLS
<b>ST01</b>	762mm (2'6")	820mm (32")	914mm (36")
<b>ST03</b>	914mm (3'0")	820mm (32")	914mm (36")
<b>ST05</b>	1067mm (3'6")	820mm (32")	914mm (36")
<b>ST07</b>	1220mm (4'0")	820mm (32")	914mm (36")

Stirling Single - 50mm Square Metal Posts

CODE STYLE

**UFCZP** 50mm Sq Flat Top, Pre-Drilled, Concrete-In  
**UFCBZP** 50mm Sq Ball Top, Pre-Drilled, Concrete-In  
**BP50X1400ZP** Flat Top, Blank Post, Concrete-In  
**BP50X1400BZP** Ball Top, Blank Post, Concrete-In

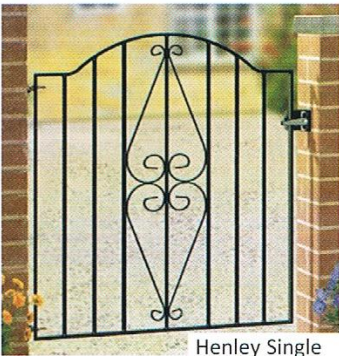

Henley Single

### Henley Low Bow Top Single Gate

Electro galvanised & black powder coat finish

Frames 25mm x 8mm

Infill Bars 10mm diameter

Frame height to shoulder 816mm

Fittings included

CODE	FITS OPENING	GATE HEIGHT
<b>HESB</b>	850-919mm (33.5-36")	942mm (37")
<b>HESC</b>	920-990mm (36-39")	942mm (37")

Henley Single - Square Metal Posts

CODE SIZE / STYLETYPE / FITS

**USDP** 50mm Sq Flat Top, Pre-Drilled, Concrete-In  
**USDB** 50mm Sq Ball Top, Pre-Drilled, Concrete-In  
**BP50X1400ZP** Flat Top, Blank Post, Concrete-In  
**BP50X1400BZP** Ball Top, Blank Post, Concrete-In



Bow Top

### Stirling Tall Bow Top Single Gate

FITTINGS INCLUDED

CODE	FITS OPENING	GATE HEIGHT
<b>ST40</b>	762mm (2'6")	1755mm (69")
<b>ST42</b>	914mm (3'0")	1830mm (72")
<b>ST44</b>	1067mm (3'6")	1905mm (75")
<b>ST46</b>	1220mm (4'0")	1980mm (78")



Double

### Stirling Double Driveway Gate FITTINGS INCLUDED

CODE	FITS OPENING	FRAME HEIGHT	TOP OF SCROLLS
<b>ST10</b>	2134mm (7'0")	820mm (32")	914mm (36")
<b>ST13</b>	2438mm (8'0")	820mm (32")	914mm (36")
<b>ST16</b>	2743mm (9'0")	820mm (32")	914mm (36")
<b>ST19</b>	3048mm (10'0")	820mm (32")	914mm (36")
<b>ST22</b>	3353mm (11'0")	820mm (32")	914mm (36")
<b>ST25</b>	3658mm (12'0")	820mm (32")	914mm (36")

Stirling Double - Square Metal Posts

CODE STYLE

Fits: ST10-ST13

**BP50X1400ZP** Flat Top, Blank Post, Concrete-In  
**BP50X1400BZP** Ball Top, Blank Post, Concrete-In

Fits: ST10-ST25

**MPZP03** 70mm Sq Flat Top, Pre-drilled, Concrete-In  
**BP70X1400ZP** Flat Top, Blank Post, Concrete-In  
**BP70X1400BZP** Ball Top, Blank Post, Concrete-In

Stirling Bow Top Tall Gate

50mm Square Metal Posts

CODE STYLE

**BP50X2350ZP** Flat Top, Blank Post, Concrete-In  
**BP50X2350BZP** Ball Top, Blank Post, Concrete-In



# Court Hoop Top

## COURT SPECIFICATIONS

Solid steel construction  
 Frames 25mm x 10mm  
 Infill bars 12mm diameter  
 Gap within hoops 100mm  
 Gap outside hoops 110mm  
 Standard is primed or powder coated black

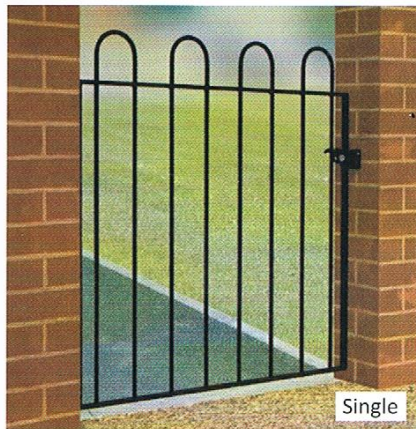

Single

**Court Single Gate** FITTINGS INCLUDED

CODE	FITS OPENING	FRAME HEIGHT	TOP OF HOOP
CR05	1000mm (3'3")	820mm (32.3")	950mm (37.4")



Railing

**Court Railing Panel** FITTINGS INCLUDED

CODE	FITS OPENING	FRAME HEIGHT	TOP OF HOOP
CR03	1830mm (6'0")	362mm (14.3")	490mm (19.3")

Court Railing - Square Metal Posts

URBZP	50mm Sq Flat Top, Pre-Drilled,	Bolt-Down
URBBZP	50mm Sq Ball Top, Pre-Drilled,	Bolt-Down
BP50X500ZP	Flat Top, Blank Post,	Bolt Down
BP50X500BZP	Ball Top, Blank Post,	Bolt Down

### Court Fence & Single Gate - Square Metal Posts

CODE	SIZE	STYLE	Fits
BP50X960ZP	50mm Sq x 960mm	Flat Top, Blank Post, Concrete-In,	CR01
BP50X960BZP	50mm Sq x 1010mm	Ball Top, Blank Post, Concrete-In,	CR01
UFBZP	50mm Sq x 1000mm	Flat Top, Pre-Drilled, Bolt-Down,	CR01
UFBBZP	50mm Sq x 1050mm	Ball Top, Pre-Drilled, Bolt-Down,	CR01
BP50X1400ZP	50mm Sq x 1400mm	Flat Top, Blank Post, Concrete-In,	CR01 & CR05
BP50X1400BZP	50mm Sq x 1450mm	Ball Top, Blank Post, Concrete-In,	CR01 & CR05
UFCZP	50mm Sq x 1400mm	Flat Top, Pre-Drilled, Concrete-In,	CR01 & CR05
UFCBZP	50mm Sq x 1450mm	Ball Top, Pre-Drilled, Concrete-In,	CR01 & CR05



Fence

**Court Fence Panel** FITTINGS INCLUDED

CODE	FITS OPENING	FRAME HEIGHT	TOP OF HOOP
CR01	1830mm (6'0")	820mm (32.3")	950mm (37.4")

See above for suitable posts

**Optional improved finish available subject to stock availability:**

Electro Galvanised & Powder Coated for added rust resistance, call the help line for the cost and the stock code.



**LIMITED MADE TO MEASURE SERVICE AVAILABLE, MUST FIT WITH THE STANDARD HOOP SIZE.**

The Court Hoop Top design fence and railing are restricted to the sizes that can be built because the hoops are a fixed size. Below are some standard sizes that can be built to fit listed openings. These sections are built to order with a lead time of up to 28 working days. We can make any height to measure, and can alter the dimension between hoops to fit your requirements.

**Court Fence - Sections** FITTINGS INCLUDED

CODE	HOOPS	FITS OPENING	FENCE HEIGHT
CRF1H	1 Hoop	270mm (11")	950mm (37")
CRF2H	2 Hoops	490mm (19")	950mm (37")
CRF3H	3 Hoops	720mm (28")	950mm (37")
CRF4H	4 Hoops	940mm (37")	950mm (37")
CRF5H	5 Hoops	1170mm (46")	950mm (37")
CRF6H	6 Hoops	1390mm (54")	950mm (37")
CRF7H	7 Hoops	1610mm (63")	950mm (37")

**Court Railing - Sections** FITTINGS INCLUDED

CODE	HOOPS	FITS OPENING	RAILING HEIGHT
CRR1H	1 Hoop	270mm (11")	492mm (19")
CRR2H	2 Hoops	490mm (19")	492mm (19")
CRR3H	3 Hoops	720mm (28")	492mm (19")
CRR4H	4 Hoops	940mm (37")	492mm (19")
CRR5H	5 Hoops	1170mm (46")	492mm (19")
CRR6H	6 Hoops	1390mm (54")	492mm (19")
CRR7H	7 Hoops	1610mm (63")	492mm (19")



# Abbey Modern



MADE TO MEASURE  
SERVICE AVAILABLE

## ABBEY SPECIFICATIONS

Solid steel construction  
Frames 25mm x 6mm  
Doubles Frame 25 x 8mm  
Infill bars 10mm and 6mm diameter  
Standard is primed or powder coated black

**Optional improved finish available on Abbey range subject to stock availability:**

Electro Galvanised & Powder Coated for added rust resistance.

Call the help line for the cost and the stock code.



Low Bow

### Abbey Low Bow Top Single Gate FITTINGS INCLUDED

CODE	FITS OPENING	GATE HEIGHT
AB52	914mm (3'0")	1340mm (52.8")
AB53	991mm (3'3")	1378mm (54.3")

Hinge height is 812mm

Abbey Low Bow - Square Metal Post option

UPZP1	50mm Sq Flat Top, Pre-Drilled, Concrete-In
BP50X1400ZP	Flat Top, Blank Post, Concrete-In
BP50X1400BZP	Ball Top, Blank Post, Concrete-In



Single

### Abbey Low Flat Top Single Gate FITTINGS INCLUDED

CODE	FITS OPENING	GATE HEIGHT
AB31	838mm (2'9")	812mm (32")
AB32	914mm (3'0")	812mm (32")
AB33	991mm (3'3")	812mm (32")

Abbey Single - Square Metal Post option

UPZP1	50mm Sq Flat Top, Pre-Drilled, Concrete-In
BP50X1400ZP	Flat Top, Blank Post, Concrete-In
BP50X1400BZP	Ball Top, Blank Post, Concrete-In



Tall Bow

### Abbey Tall Bow Top Single Gate FITTINGS INCLUDED

CODE	FITS OPENING	GATE HEIGHT
AB42	914mm (3'0")	1950mm (76.8")
AB43	991mm (3'3")	1988mm (78.3")

Abbey Bow Top - Square Metal Post option

UPZP2	50mm Sq Flat Top, Pre-Drilled, Concrete-In
BP50X2350ZP	Flat Top, Blank Post, Concrete-In
BP50X2350BZP	Ball Top, Blank Post, Concrete-In



Fence

### Abbey Fence Panel FITTINGS INCLUDED

CODE	FITS OPENING	FENCE HEIGHT
AB01	1830mm (6'0")	812mm (32")

Abbey Fence - Square Metal Post option

BP50X960ZP	Flat Top, Blank Post, Bolt-Down
BP50X960BZP	Ball Top, Blank Post, Bolt-Down
UPZP1	50mm Sq Flat Top, Pre-Drilled, Concrete-In
BP50X1400ZP	Flat Top, Blank Post, Concrete-In
BP50X1400BZP	Ball Top, Blank Post, Concrete-In



Railing

### Abbey Railing Panel FITTINGS INCLUDED

CODE	FITS OPENING	RAILING HEIGHT
AB06	1830mm (6'0")	395mm (15.6")

Abbey Railing - Square Metal Post options

BP50X500ZP	Flat Top, Blank Post, Bolt Down
BP50X500BZP	Ball Top, Blank Post, Bolt Down



# Abbey Modern



LIMITED MADE TO MEASURE SERVICE  
AVAILABLE DUE TO PATTERN BEING A  
FIXED SIZE.



AB10 Double



AB14 Double

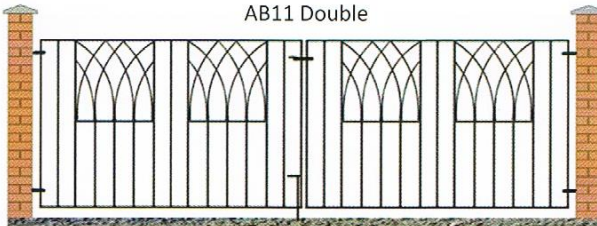

AB11 Double



AB12 Double

## Abbey Double Driveway Gate FITTINGS INCLUDED

CODE	FITS OPENING	GATE HEIGHT
AB10	2385-2445mm (93.9-96.3")	812mm (32")
AB11	2725-2785mm (107.3-109.7")	812mm (32")
AB12	3065-3125mm (120.7-123.1")	812mm (32")
AB13	3235-3295mm (127.4-129.8")	812mm (32")
AB14	3510-3565mm (138.1-140.5")	812mm (32")

Abbey Double Gates - Square Metal Posts

CODE	STYLE	
MPZP03	70mm Sq Flat Top, Pre-drilled,	Concrete-In
BP70X1400ZP	Flat Top, Blank Post,	Concrete-In
BP70X1400BZP	Ball Top, Blank Post,	Concrete-In



AB13 Double

# Verona Modern



## VERONA SPECIFICATIONS

Solid steel construction  
Electro galvanised & black powder coat finish  
Frames 25mm x 8mm  
Infill bars 10mm and 6mm diameter  
Frame height to shoulder 816mm

Verona Single

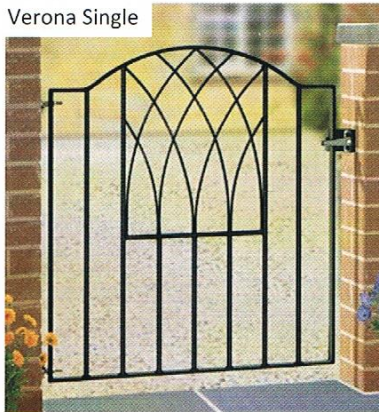

## Verona Low Bow Top Single Gate FSTB FITTINGS INCLUDED

CODE	FITS OPENING	GATE HEIGHT
VESB	850-919mm (33.5-36")	942mm (37")
VESC	920-990mm (36-39")	942mm (37")

Shoulder frame height is 816mm

Verona Single - Square Metal Posts

CODE	SIZE	STYLE	
USDP	50mm Sq	Flat Top, Pre-Drilled,	Concrete-In
USDB	50mm Sq	Ball Top, Pre-Drilled,	Concrete-In
BP50X1400ZP	Flat Top, Blank Post,	Concrete-In	
BP50X1400BZP	Ball Top, Blank Post,	Concrete-In	

Verona Tall Single

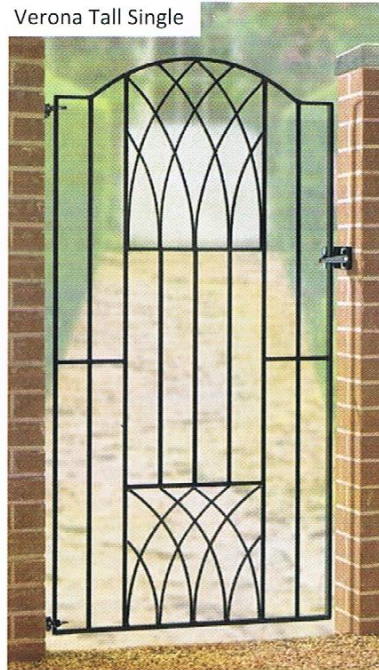

## Verona Tall Bow Top Single Gate FSTB FITTINGS INCLUDED

CODE	FITS OPENING	GATE HEIGHT
VETB	850-919mm (33.5-36")	1798mm (70.8")
VETC	920-990mm (36-39")	1798mm (70.8")

Shoulder frame height is 1672mm

Verona Tall Single - Square Metal Posts

CODE	SIZE	STYLE	
UTBP	50mm Sq	Flat Top, Pre-Drilled,	Concrete-In
UTBB	50mm Sq	Ball Top, Pre-Drilled,	Concrete-In
BP50X2350ZP	Flat Top, Blank Post,	Concrete-In	
BP50X2350BZP	Ball Top, Blank Post,	Concrete-In	



# Manor Ball Top



**Manor Arched Railing Panel** FITTINGS INCLUDED  
 CODE FITS OPENING RAILING HEIGHTS  
**MA04** 1830mm (6'0") 360mm (14.2") side frame height,  
 455mm (17.9") side to top of finial,  
 625mm (24.6") centre top of finial.

Limited Made-to-Measure on Arched Railing, smaller opening sizes can be an issue when shaping the bow to look similar to the rest of the standard panels.

**Manor Flat Railing Panel** FITTINGS INCLUDED  
 CODE FITS OPENING FRAME HEIGHT TOP OF FINIAL  
**MA03** 1830mm (6'0") 360mm (14.2") 455mm (18")

Manor Railing - Square Metal Posts for MA03 & MA04

CODE	SIZE	STYLE
<b>URBZP</b>	50mm Sq	Flat Top, Pre-Drilled, Bolt-Down
<b>URBBZP</b>	50mm Sq	Ball Top, Pre-Drilled, Bolt-Down
<b>BP50X500ZP</b>		Flat Top, Blank Post, Bolt Down
<b>BP50X500BZP</b>		Ball Top, Blank Post, Bolt Down

## MANOR SPECIFICATIONS

Solid steel construction  
 Frames 25mm x 10mm  
 Infill bars 12mm diameter  
 Standard is primed or powder coated black

**Optional improved finish available subject to stock availability:**

Electro Galvanised & Powder Coated for added rust resistance.  
 Call the help line for the cost and the stock code.



**Manor Fence Panel** FITTINGS INCLUDED  
 CODE FITS OPENING FRAME HEIGHT TOP OF FINIAL  
**MA01** 1830mm (6'0") 820mm (32") 915mm (36")  
**MA02** 1830mm (6'0") 1125mm (44") 1220mm (48")

Manor MA01 & MA02 Fence - Square Metal Post

CODE	SIZE	STYLE	FITS
<b>UFBZP</b>	50mm Sq	Flat Top, Pre-Drilled, Bolt-Down,	MA01
<b>UFBBZP</b>	50mm Sq	Ball Top, Pre-Drilled, Bolt-Down,	MA01
<b>BP50X960ZP</b>		Flat Top, Blank Post, Bolt-Down,	MA01
<b>BP50X960BZP</b>		Ball Top, Blank Post, Bolt-Down,	MA01
<b>UFCZP</b>	50mm Sq	Flat Top, Pre-Drilled, Concrete-In,	MA01
<b>UFBCZP</b>	50mm Sq	Ball Top, Pre-Drilled, Concrete-In,	MA01
<b>BP50X1400ZP</b>		Flat Top, Blank Post, Concrete-In,	MA01
<b>BP50X1400BZP</b>		Ball Top, Blank Post, Concrete-In,	MA01
<b>BP50X1600ZP</b>		Flat Top, Blank Post, Concrete-In,	MA02
<b>BP50X1600BZP</b>		Ball Top, Blank Post, Concrete-In,	MA02

Blank Posts are better suited to uneven ground conditions, allowing the brackets to be positioned as required on the post, on-site drilling will be required.

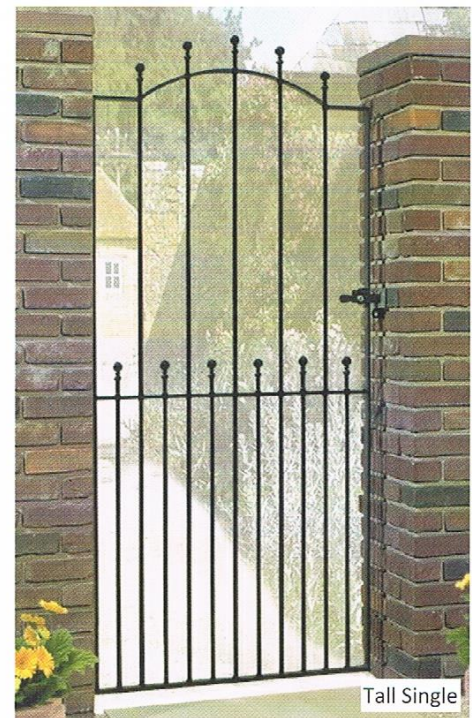

**Manor Tall Bow Top Single Gate** FITTINGS INCLUDED

CODE	FITS OPENING	TOP OF FINIAL
<b>MA30</b>	762mm (2'6")	1943mm (76.5")
<b>MA32</b>	914mm (3'0")	1943mm (76.5")
<b>MA34</b>	1067mm (3'6")	1943mm (76.5")
<b>MA36</b>	1220mm (4'0")	1943mm (76.5")

Shoulder frame height is 1772mm

Manor Tall Single - Square Metal Post options

CODE	SIZE	STYLE
<b>BP50X2350ZP</b>		Flat Top, Blank Post, Concrete-In
<b>BP50X2350BZP</b>		Ball Top, Blank Post, Concrete-In



# Manor Ball Top



**MADE TO MEASURE SERVICE  
AVAILABLE ON MANOR RANGE**

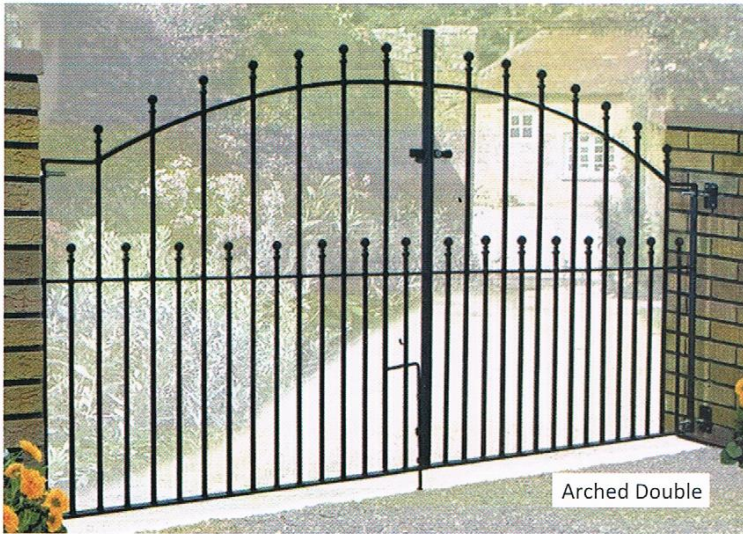

Arched Double

**Manor Arched Double Gate** FITTINGS INCLUDED

CODE	FITS OPENING	CENTRE TOP OF FINIAL
MA10	2134mm (7'0")	1220mm (48")
MA13	2438mm (8'0")	1220mm (48")
MA16	2743mm (9'0")	1220mm (48")
MA19	3048mm (10'0")	1220mm (48")
MA22	3353mm (11'0")	1220mm (48")
MA25	3658mm (12'0")	1220mm (48")

Frame SIDE shoulder height is 820mm.

Manor Arched Double - Square Metal Post

CODE	SIZE	STYLE
------	------	-------

Fits: MA10-MA13

**BP50X1400ZP** Flat Top, Blank Post, Concrete-In

**BP50X1400BZP** Ball Top, Blank Post, Concrete-In

Fits: MA10-MA25

**MPZP03** 70mm Sq Flat Top, Pre-drilled, Concrete-In

**BP70X1400ZP** Flat Top, Blank Post, Concrete-In

**BP70X1400BZP** Ball Top, Blank Post, Concrete-In

Flat Double

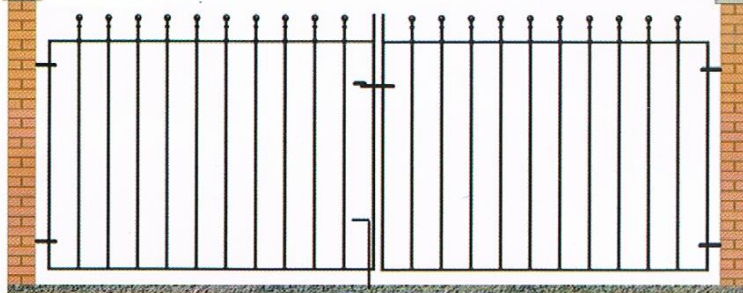

**Manor Flat Double Gate** FITTINGS INCLUDED

CODE	FITS OPENING	TOP OF FINIAL
MA40	2134mm (7'0")	915mm (36")
MA43	2438mm (8'0")	915mm (36")
MA46	2743mm (9'0")	915mm (36")
MA49	3048mm (10'0")	915mm (36")
MA52	3353mm (11'0")	915mm (36")
MA55	3658mm (12'0")	915mm (36")

Frame shoulder height is 820mm.

Manor Flat Double - Square Metal Post

CODE	SIZE	STYLE
------	------	-------

Fits: MA40-MA43

**BP50X1400ZP** Flat Top, Blank Post, Concrete-In

**BP50X1400BZP** Ball Top, Blank Post, Concrete-In

Fits: MA40-MA55

**MPZP03** 70mm Sq Flat Top, Pre-drilled, Concrete-In

**BP70X1400ZP** Flat Top, Blank Post, Concrete-In

**BP70X1400BZP** Ball Top, Blank Post, Concrete-In

Manor Flat Doubles and Arch Doubles are usually held in lower stock levels, thus may on occasion be made to order, thus delivery can be up to 28 days.  
Call our Trade Helpline to confirm stock holding and delivery times.



Manor Single

**Manor Single Gate** FITTINGS INCLUDED

CODE	FITS OPENING	TOP OF FINIAL
MA05/1	762mm (2'6")	915mm (36")
MA05/3	914mm (3'0")	915mm (36")
MA05/5	1067mm (3'6")	915mm (36")

Frame shoulder height is 820mm.

Manor Single - Square Metal Post options

CODE	SIZE	STYLE
------	------	-------

**UFCZP** 50mm Sq Flat Top, Pre-Drilled, Concrete-In

**UFCBZP** 50mm Sq Ball Top, Pre-Drilled, Concrete-In

**BP50X1400ZP** Flat Top, Blank Post, Concrete-In

**BP50X1400BZP** Ball Top, Blank Post, Concrete-In



Weston Single

## Weston

**WESTON SPECIFICATIONS**

Solid steel construction

Electro galvanised & black powder coated

Frames 25mm x 8mm

Infill bars 12mm diameter

Frame height does not match Manor gate or fence height.



**Weston Low Bow Top Single Gate** FITTINGS INCLUDED

CODE	FITS OPENING	TOP OF FINIAL
WESB	850-919mm (33.5-36")	1041mm (41")
WESC	920-990mm (36-39")	1041mm (41")

Frame shoulder height is 816mm.

Weston Single - Square Metal Posts

CODE	SIZE	STYLE
------	------	-------

**USDP** 50mm Sq Flat Top, Pre-Drilled, Concrete-In

**USDB** 50mm Sq Ball Top, Pre-Drilled, Concrete-In

**BP50X1400ZP** Flat Top, Blank Post, Concrete-In

**BP50X1400BZP** Ball Top, Blank Post, Concrete-In



# Saxon Fleur-de-Lys Spear Top



## SAXON & GAELIC SPECIFICATIONS

Solid steel construction  
 Frames 25mm x 10mm  
 Infill bars 12mm diameter  
 Standard is primed or powder coated black



MADE TO MEASURE SERVICE AVAILABLE

**Optional improved finish available subject to stock availability:**  
 Electro Galvanised & Powder Coated for added rust resistance.  
 Call the help line for the cost and the stock code.



Arch Railing

**Saxon Arched Railing Panel** FITTINGS INCLUDED  
 CODE FITS OPENING RAILING HEIGHTS  
**SA04** 1830mm (6'0") 360mm (14.2") side frame height  
 490mm (19.3") side to top of finial,  
 660mm (26") centre top of finial.

Limited Made-to-Measure on Arched Railing, smaller opening sizes can be an issue when shaping the bow to look similar to the rest of the standard panels.

Saxon - Square Metal Posts for **SA04**  
**URBZP** 50mm Sq Flat Top, Pre-Drilled, Bolt-Down  
**URBBZP** 50mm Sq Ball Top, Pre-Drilled, Bolt-Down  
**BP50X500ZP** Flat Top, Blank Post, Bolt Down  
**BP50X500BZP** Ball Top, Blank Post, Bolt Down



Flat Railing

**Saxon Flat Railing Panel** FITTINGS INCLUDED  
 CODE FITS OPENING FRAME HEIGHT TOP OF FINIAL  
**SA03** 1830mm (6'0") 360mm (14.2") 490mm (19.3")

Saxon - Square Metal Posts for **SA03**  
**URBZP** 50mm Sq Flat Top, Pre-Drilled, Bolt-Down  
**URBBZP** 50mm Sq Ball Top, Pre-Drilled, Bolt-Down  
**BP50X500ZP** Flat Top, Blank Post, Bolt Down  
**BP50X500BZP** Ball Top, Blank Post, Bolt Down



Fence

**Saxon Fence Panel** FITTINGS INCLUDED  
 CODE FITS OPENING FRAME HEIGHT TOP OF FINIAL  
**SA01** 1830mm (6'0") 820mm (32.3") 950mm (37.4")

Saxon **SA01** - Square Metal Post  
 CODE SIZE STYLE  
**UFBZP** 50mm Sq Flat Top, Pre-Drilled, Bolt-Down  
**UFBZP** 50mm Sq Ball Top, Pre-Drilled, Bolt-Down  
**BP50X960ZP** Flat Top, Blank Post, Bolt-Down  
**BP50X960BZP** Ball Top, Blank Post, Bolt-Down  
**UFCZP** 50mm Sq Flat Top, Pre-Drilled, Concrete-In  
**UFCBZP** 50mm Sq Ball Top, Pre-Drilled, Concrete-In  
**BP50X1400ZP** Flat Top, Blank Post, Concrete-In  
**BP50X1400BZP** Ball Top, Blank Post, Concrete-In

Blank Posts are better suited to uneven ground conditions, allowing the brackets to be positioned as required on the post, on-site drilling will be required.



Tall Single

**Saxon Tall Bow Top Single Gate** FITTINGS INCLUDED  
 CODE FITS OPENING TOP OF FINIAL  
**SA30** 762mm (2'6") 1970mm (77.6")  
**SA32** 914mm (3'0") 1970mm (77.6")  
**SA34** 1067mm (3'6") 1970mm (77.6")  
**SA36** 1220mm (4'0") 1970mm (77.6")

Shoulder frame height is 1772mm

Saxon Tall Single - Square Metal Post options  
 CODE SIZE STYLE  
**BP50X2350ZP** Flat Top, Blank Post, Concrete-In  
**BP50X2350BZP** Ball Top, Blank Post, Concrete-In



# Saxon Fleur-de-Lys Spear Top



MADE TO MEASURE  
SERVICE AVAILABLE

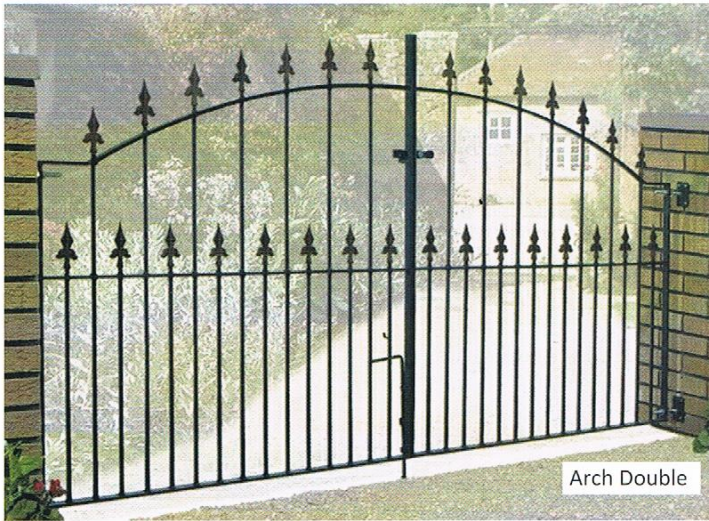

Arch Double

## Saxon Arched Double Gate FITTINGS INCLUDED

CODE	FITS OPENING	CENTRE TOP OF FINIAL
SA10	2134mm (7'0")	1255mm (49.4")
SA13	2438mm (8'0")	1255mm (49.4")
SA16	2743mm (9'0")	1255mm (49.4")
SA19	3048mm (10'0")	1255mm (49.4")
SA22	3353mm (11'0")	1255mm (49.4")
SA25	3658mm (12'0")	1255mm (49.4")

Frame SIDE shoulder height is 820mm.

## Saxon Arched Double - Square Metal Post

CODE	SIZE	STYLE
Fits: SA10-SA13		
BP50X1400ZP	50mm Sq	Flat Top, Blank Post, Concrete-In
BP50X1400BZP	50mm Sq	Ball Top, Blank Post, Concrete-In
Fits: SA10-SA25		
MPZP03	70mm Sq	Flat Top, Pre-drilled, Concrete-In
BP70X1400ZP	70mm Sq	Flat Top, Blank Post, Concrete-In
BP70X1400BZP	70mm Sq	Ball Top, Blank Post, Concrete-In



Double

## Saxon Flat Double Gate FITTINGS INCLUDED

CODE	FITS OPENING	TOP OF FINIALS
SA40	2134mm (7'0")	950mm (37.4")
SA43	2438mm (8'0")	950mm (37.4")
SA46	2743mm (9'0")	950mm (37.4")
SA49	3048mm (10'0")	950mm (37.4")
SA52	3353mm (11'0")	950mm (37.4")
SA55	3658mm (12'0")	950mm (37.4")

Frame shoulder height is 820mm.

## Saxon Flat Double - Square Metal Post

CODE	SIZE	STYLE
Fits: SA40-SA43		
BP50X1400	50mm Sq	Flat Top, Blank Post, Concrete-In
BP50X1400B	50mm Sq	Ball Top, Blank Post, Concrete-In
Fits: SA40-SA55		
MPZP03	70mm Sq	Flat Top, Pre-drilled, Concrete-In
BP70X1400	70mm Sq	Flat Top, Blank Post, Concrete-In
BP70X1400B	70mm Sq	Ball Top, Blank Post, Concrete-In

Saxon Flat Doubles and Arch Double gates are usually held in lower stock levels, thus may on occasion be made to order, thus delivery can be up to 28 days.  
Call our Trade Helpline to confirm stock holding and delivery times.



Saxon Single

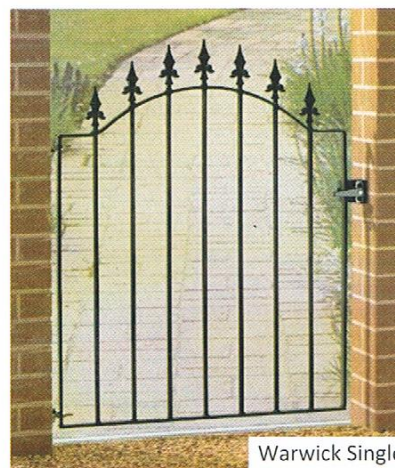

Warwick Single

# Warwick

**WARWICK SPECIFICATIONS**  
Solid steel construction  
Electro galvanised & black powder coated  
Frames 25mm x 8mm  
Infill bars 12mm diameter  
Frame height does not match Weston gate or fence height.



## Saxon Single Gate FITTINGS INCLUDED

CODE	FITS OPENING	TOP OF FINIALS
SA05/1	762mm (2'6")	950mm (37.4")
SA05/3	914mm (3'0")	950mm (37.4")
SA05/5	1067mm (3'6")	950mm (37.4")

Frame shoulder height is 820mm.

## Saxon Single - Square Metal Post options

CODE	SIZE	STYLE
UFCZP	50mm Sq	Flat Top, Pre-Drilled, Concrete-In
UFCBZP	50mm Sq	Ball Top, Pre-Drilled, Concrete-In
BP50X1400ZP	50mm Sq	Flat Top, Blank Post, Concrete-In
BP50X1400BZP	50mm Sq	Ball Top, Blank Post, Concrete-In

## Warwick Low Bow Top Single Gate FITTINGS INCLUDED

CODE	FITS OPENING	TOP OF FINIALS
WASB	850-919mm (33.5-36.2")	1076mm (42.4")
WASC	920-990mm (36.2-39")	1076mm (42.4")

Frame SIDE shoulder height is 816mm.

## Warwick Single - Square Metal Posts

CODE	SIZE	STYLE
USDSP	50mm Sq	Flat Top, Pre-Drilled, Concrete-In
USDB	50mm Sq	Ball Top, Pre-Drilled, Concrete-In
BP50X1400ZP	50mm Sq	Flat Top, Blank Post, Concrete-In
BP50X1400BZP	50mm Sq	Ball Top, Blank Post, Concrete-In



# Corfe Premium Fleur-de-Lys



MADE TO MEASURE SERVICE AVAILABLE

## CORFE SPECIFICATIONS

Solid steel construction  
 Heavy duty 25mm x 25mm box section frames  
 Infill bars 16mm diameter  
 Bow Frame 25mm x 10mm on Tall Split Bow  
 Standard Finish: Primed black.

## Corfe Information

Corfe gates have adjustable hinges for levelling on installation.  
 All Corfe gates have the closing bolt on the right hand inside when viewed from the road.  
 Corfe Spear heads are primed black, not as pictured.  
**Corfe range is made to order, delivery up to 28 days, call the Trade Helpline to confirm stock levels and delivery times.**

## Optional improved finish available on Corfe range:

Hot Dip Galvanised for the best form of rust resistance or Electro Galvanised for added rust resistance, and Powder Coated black.  
 Other colours available on request.  
 Please call the help line for a quotation.



Single

**Corfe Single Gate** FITTINGS INCLUDED

CODE	FITS	OPENING	TOP OF FINIALS
CF01	762mm	(2'6")	1168mm (46")
CF03	914mm	(3'0")	1168mm (46")
CF04	991mm	(3'3")	1168mm (46")
CF05	1067mm	(3'6")	1168mm (46")

Corfe Single - Square Metal Posts

CODE	SIZE	STYLE
MP15H	70mm Sq x 1830mm	Flat Top, Hinge, Concrete-In
MP15L	70mm Sq x 1830mm	Flat Top, Latch, Concrete-In

**Corfe Tall Single Gate** FITTINGS INCLUDED

CODE	FITS	OPENING	TOP OF FINIALS
CF30	762mm	(2'6")	1778mm (70")
CF32	914mm	(3'0")	1778mm (70")
CF33	991mm	(3'3")	1778mm (70")
CF34	1067mm	(3'6")	1778mm (70")

Corfe Tall Single - Square Metal Posts

CODE	SIZE	STYLE
MP18H	70mm Sq x 2400mm	Flat Top, Hinge, Concrete-In
MP18L	70mm Sq x 2400mm	Flat Top, Latch, Concrete-In

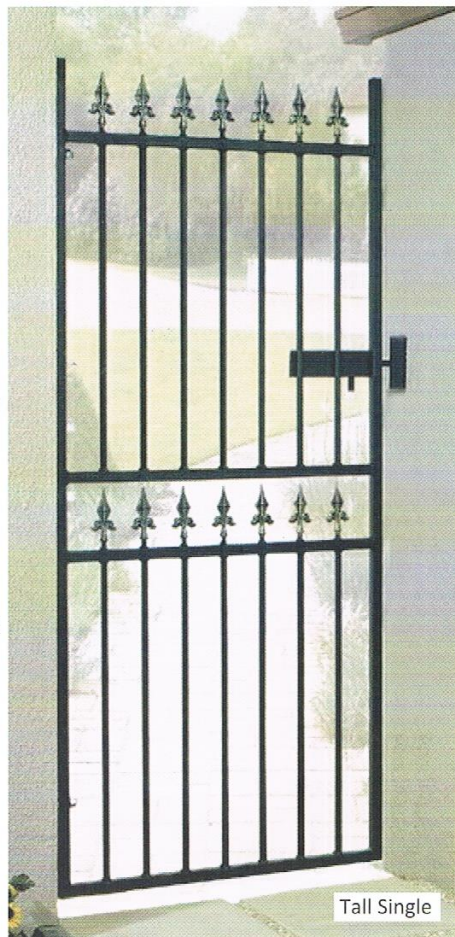

Tall Single



Double

**Corfe Low Double Gate** FITTINGS INCLUDED

CODE	FITS	OPENING	TOP OF FINIALS
CF10	2134mm	(7'0")	1168mm (46")
CF13	2438mm	(8'0")	1168mm (46")
CF16	2743mm	(9'0")	1168mm (46")
CF19	3048mm	(10'0")	1168mm (46")
CF22	3353mm	(11'0")	1168mm (46")
CF25	3658mm	(12'0")	1168mm (46")

Corfe Double - Square Metal Posts

CODE	SIZE	STYLE
Fits:	CF10-CF16	
MP15H	70mm Sq x 1830mm,	Flat Top, Hinge, Concrete-In
Fits:	CF10-CF25	
MP21H	100mm Sq x 1830mm,	Flat Top, Hinge, Concrete-In



# Corfe Premium Fleur-de-Lys



**MADE TO MEASURE  
SERVICE AVAILABLE**

## CORFE SPECIFICATIONS

Solid steel construction  
Heavy duty 25mm x 25mm box section frames  
Infill bars 16mm diameter  
Bow Frame 25mm x 10mm on Tall Split Bow  
Standard Finish: Primed black.

## Corfe Information

Corfe gates have adjustable hinges for levelling on installation.  
All Corfe gates have the closing bolt on the right hand inside when viewed from the road.  
Corfe Spear heads are primed black, not as pictured.  
Corfe range is made to order, delivery up to 28 days, call the Trade Helpline to confirm stock levels and delivery times.

### Corfe Tall Flat Double FITTINGS INCLUDED

CODE	FITS OPENING	TOP OF FINIALS
CF60	2134mm (7'0")	1778mm (70")
CF61	2438mm (8'0")	1778mm (70")
CF62	2743mm (9'0")	1778mm (70")
CF63	3048mm (10'0")	1778mm (70")
CF64	3353mm (11'0")	1778mm (70")
CF65	3658mm (12'0")	1778mm (70")

### Corfe Tall Double - Square Metal Posts

CODE	SIZE	STYLE
Fits:	CF60-CF62	
<b>MP18H</b>	70mm Sq 2400mm, Hinge, Concrete-In	
Fits:	CF60-CF65	
<b>MP23H</b>	100mm Sq x 2400mm, Hinge, Concrete-In	



Tall Double



Split Bow

### Corfe Tall Bow Double FITTINGS INCLUDED

CODE	FITS OPENING	TOP OF FINIALS
CF90	2134mm (7'0")	2083mm (82")
CF91	2438mm (8'0")	2083mm (82")
CF92	2743mm (9'0")	2083mm (82")
CF93	3048mm (10'0")	2083mm (82")
CF94	3353mm (11'0")	2083mm (82")
CF95	3658mm (12'0")	2083mm (82")

Arch rises from 1778mm to 2083mm, top of finials.

### Corfe Tall Split Bow - Square Metal Posts

CODE	SIZE	STYLE
Fits:	CF90-CF91	
<b>MP18H</b>	70mm Sq x 2400mm, Hinge, Concrete-In	
Fits:	CF90-CF95	
<b>MP23H</b>	100mm Sq x 2400mm, Hinge, Concrete-In	



# Balmoral Premium Spear Top



LIMITED MADE TO MEASURE  
DUE TO FIXED RING SIZE

## BALMORAL SPECIFICATIONS

Solid steel construction  
Heavy duty 40mm x 10mm frames  
Infill bars 16mm diameter  
Tall Double gate hanging stiles 40mm x 30mm  
Standard Finish: Primed black.

## Balmoral Information

Balmoral gates have adjustable hinges for levelling on installation.  
All Balmoral gates have the closing bolt on the right hand inside when viewed from the road.  
Balmoral Spear heads are primed black, not as pictured.  
Balmoral range is made to order, delivery up to 28 days, call the Trade Helpline to confirm stock levels and delivery times.

**Optional improved finish available on Balmoral range:**  
Hot Dip Galvanised for the best form of rust resistance or Electro Galvanised for added rust resistance, and Powder Coated black.  
Other colours available on request.  
Please call the help line for a quotation.

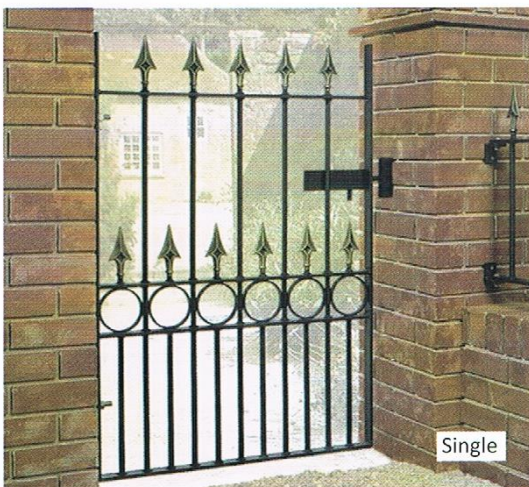

Single

**Balmoral Single Gate** FITTINGS INCLUDED  
CODE FITS OPENING TOP OF FINIALS  
BA03 914mm (3'0") 1168mm (46")  
BA05 1067mm (3'6") 1168mm (46")

Balmoral Single - Square Metal Posts

CODE SIZE STYLE  
MP15H 70mm Sq x 1830mm, Flat Top, Hinge, Concrete-In  
MP15L 70mm Sq x 1830mm, Flat Top, Latch, Concrete-In



Tall Single

**Balmoral Tall Single Gate** FITTINGS INCLUDED  
CODE FITS OPENING TOP OF FINIALS  
BA32 914mm (3'0") 1905mm (75")  
BA34 1067mm (3'6") 1905mm (75")

Balmoral Tall Single - Square Metal Posts

CODE SIZE STYLE  
MP18H 70mm Sq x 2400mm, Flat Top, Hinge, Concrete-In  
MP18L 70mm Sq x 2400mm, Flat Top, Latch, Concrete-In

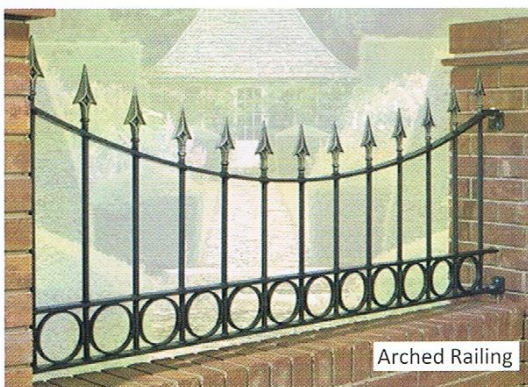

Arched Railing

## Balmoral Shaped Railing Panel

FITTINGS INCLUDED  
CODE FITS OPENING PANEL SIDE HEIGHT  
BAP06 1830mm (6'0") 735mm (29")

**Balmoral Railing - Square Metal Posts**  
Blank bolt down posts to suit your application available on request



Railing

**Balmoral Plain Railing Panel** FITTINGS INCLUDED  
CODE FITS OPENING FRAME HEIGHT TOP OF FINIALS  
BAR06 1830mm (6'0") 407mm (16") 560mm (22")



# Balmoral Premium Spear Top



LIMITED MADE TO MEASURE  
DUE TO FIXED RING SIZE

## BALMORAL SPECIFICATIONS

Solid steel construction  
Heavy duty 40mm x 10mm frames  
Infill bars 16mm diameter  
Tall Double gate hanging stiles 40mm x 30mm  
Standard Finish: Primed black.

## Balmoral Information

Balmoral gates have adjustable hinges for levelling on installation.  
All Balmoral gates have the closing bolt on the right hand side when viewed from the road.  
Balmoral Spear heads are primed black, not as pictured.  
Balmoral range is made to order, delivery up to 28 days, call the Trade Helpline to confirm stock levels and delivery times.



## Balmoral Low Double Driveway Gate

### FITTINGS INCLUDED

CODE	FITS OPENING	TOP OF FINIALS
BA10	2134mm (7'0")	1168mm (46")
BA13	2438mm (8'0")	1168mm (46")
BA15	2743mm (9'0")	1168mm (46")
BA19	3048mm (10'0")	1168mm (46")
BA20	3353mm (11'0")	1168mm (46")
BA21	3658mm (12'0")	1168mm (46")

Balmoral Double - Square Metal Posts

CODE SIZE STYLE

Fits: BA10-BA15

MP15H 70mm Sq x 1830mm, Hinge, Concrete-In

Fits: BA10-BA21

MP21H 100mm Sq x 1830mm, Hinge, Concrete-In

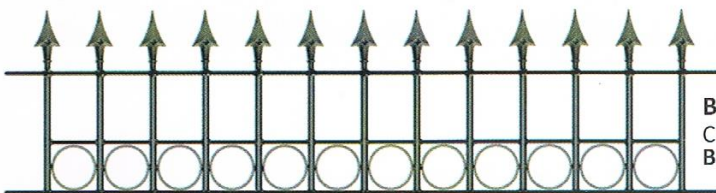

**NEW!**

## Balmoral Rings Railing Panel

### FITTINGS INCLUDED

CODE	FITS OPENING	FRAME HEIGHT	TOP OF FINIALS
BAR07	1830mm (6'0")	407mm (16")	560mm (22")

## Balmoral Tall Bow Top Double Gate

### FITTINGS INCLUDED

CODE	FITS OPENING	TOP OF FINIALS
BA90	2134mm (7'0")	2082mm (82")
BA91	2438mm (8'0")	2082mm (82")
BA92	2743mm (9'0")	2082mm (82")
BA93	3048mm (10'0")	2082mm (82")
BA94	3353mm (11'0")	2082mm (82")
BA95	3658mm (12'0")	2082mm (82")

Arch rises from 1775mm to 2082mm,  
Top of finials.

Hinge brackets supplied may not be as pictured.

Balmoral Tall Double - Square Metal Posts

CODE SIZE STYLE

Fits: BA90-BA91

MP18H 70mm Sq x 2400mm, Hinge, Concrete-In

Fits: BA90-BA95

MP23H 100mm Sq x 2400mm, Hinge, Concrete-In

MP24 150mm Sq x 2400mm, Hinge, Concrete-In



Bow Top Double



# Metal Deck Panels



~~MADE TO MEASURE SERVICE IS NOT AVAILABLE ON DECK PANELS~~

Wooden posts and hand rails are not included.



**Garda Deck Panel** - pack of 2  
 PACK CODE **DPGB** COLOUR **BLACK**  
 HEIGHT 770mm (30.25") WIDTH 280mm (11")



**Ascot Deck Panel** - pack of 2  
 PACK CODE **DPAB** COLOUR **BLACK**  
 HEIGHT 770mm (30.25") WIDTH 280mm (11")



**Metro Deck Panel** - pack of 2  
 PACK CODE **DPMB** COLOUR **BLACK**  
 HEIGHT 770mm (30.25") WIDTH 280mm (11")



**Plaza Deck Panel** - pack of 2  
 PACK CODE **DPPS** COLOUR **SILVER**  
 HEIGHT 770mm (30.25") WIDTH 280mm (11")



**Coast Deck Panel** - pack of 2  
 PACK CODE **DPCB** COLOUR **BLACK**  
 HEIGHT 770mm (30.25") WIDTH 280mm (11")



**Swirl Deck Panel** - pack of 2  
 PACK CODE **DPSS** COLOUR **SILVER**  
 HEIGHT 770mm (30.25") WIDTH 280mm (11")

## DECK PANEL SPECIFICATIONS

For screw fixing between timber posts and hand rails.  
 Solid steel construction.  
 Electro galvanised for added rust resistance and powder coated finish.  
 16mm x 6mm Flat bar top and base rails.  
 Infill bars 10mm diameter.  
 Scrollwork 10mm x 3mm.

EACH PACK: TWO PANELS TO FORM A RUN OF 560mm  
 Screws are not included.  
 Wooden posts and hand rails are not included.

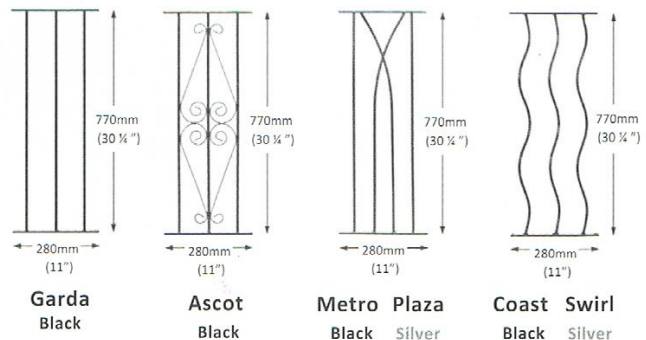



# Large Metal Deck Panels



~~MADE TO MEASURE SERVICE IS NOT AVAILABLE ON DECK PANELS~~

## DECK PANEL SPECIFICATIONS

For screw fixing between timber posts and hand rails.  
Solid steel construction.  
Electro galvanised for added rust resistance and powder coated finish.  
16mm x 6mm Flat bar top and base rails  
Infill bars 12mm and 6mm diameter

EACH PACK: ONE PANEL TO FORM A RUN OF 560mm  
Screws are not included.  
Wooden posts and hand rails are not included.

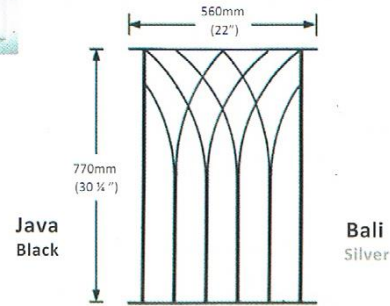

**Java Deck Panel** - pack of 1  
PACK CODE **DPJB** COLOUR **BLACK**  
HEIGHT 770mm (30.25") WIDTH 560mm (22")



**Bali Deck Panel** - pack of 1  
PACK CODE **DPBS** COLOUR **SILVER**  
HEIGHT 770mm (30.25") WIDTH 560mm (22")

## LARGE DECK PANELS (FOR FIXING TO BOLT DOWN METAL OR WOODEN DECK DOWN POSTS)

Solid steel construction - Electro galvanised powder powder coat finish  
40mm x 6mm flat bar top rail, 25mm x 6mm flat bar bottom rail,  
RIPPLE and DECO Infill bars 10 mm diameter  
NOVA Infill bars 12mm and 6mm diameter

~~MADE TO MEASURE SERVICE IS NOT AVAILABLE ON DECK PANELS~~



**Deco** FITTINGS INCLUDED  
PANEL CODE **LPDB** COLOUR **BLACK**  
HEIGHT 813mm (32) WIDTH 1130mm (44.5")



**Ripple** FITTINGS INCLUDED  
PANEL CODE **LPRB** COLOUR **BLACK**  
HEIGHT 813mm (32) WIDTH 1130mm (44.5")



**Nova** FITTINGS INCLUDED  
PANEL CODE **LPNB** COLOUR **BLACK**  
HEIGHT 813mm (32) WIDTH 1130mm (44.5")



### Large Deck Panels - Square Metal Post

CODE	SIZE	STYLE
<b>LPPB</b>	50x915mm	Flat Top, Pre-Drilled, Bolt-Down
<b>BP50X960ZP</b>		Flat Top, Blank Post, Bolt-Down
<b>BP50X960BZP</b>		Ball Top, Blank Post, Bolt-Down

Blank Posts are better suited to uneven ground conditions, allowing the brackets to be positioned as required on the post, on-site drilling will be required.



Deco, Ripple and Nova metal deck panels are supplied with brackets and fittings for fixing to metal posts, to brickwork or wooden posts.



# Garden Rose Arches

## ROSE ARCH SPECIFICATIONS

Side panels are manufactured in one complete section.  
 Side panels have solid steel infill bars.  
 The main outer frame and arches are 16mm diameter hollow tube  
 See below for other steel sizes.  
 Powder coated black finish, will require periodic painting.  
 Easy DIY build, no tools required.

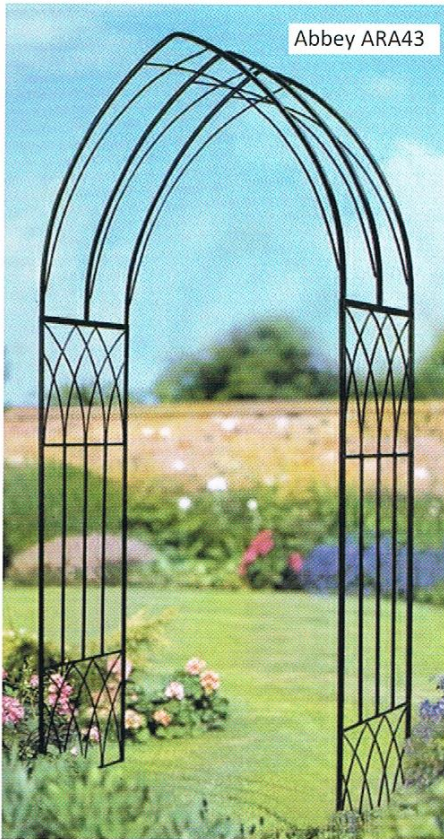

Abbey ARA43

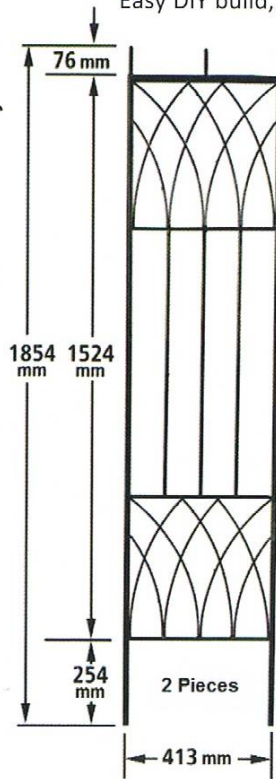

MADE TO MEASURE SERVICE IS NOT AVAILABLE ON ROSE ARCHES

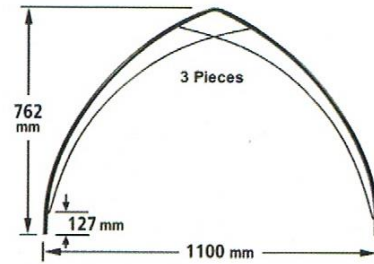

### Abbey Modern Rose Arch

CODE	HEIGHT	WIDTH	DEPTH
ARA43	2286mm	1100mm	410mm

Crossbar frame 20x6mm solid flat bar.  
 Round frame infill bars 10mm diameter.  
 Pattern infill bars 6mm diameter.



York Small YRA42

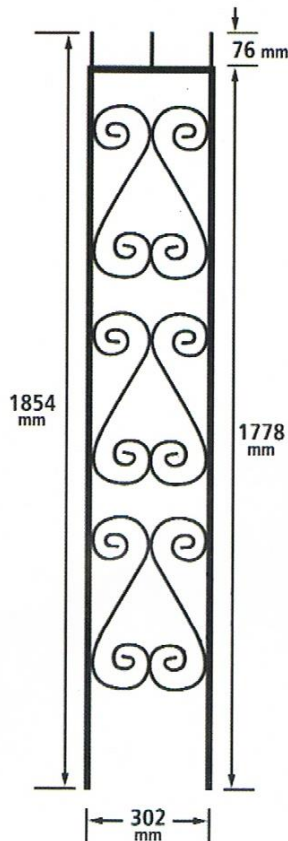

York Large YRA60

### York Scroll Small Rose Arch

CODE	HEIGHT	WIDTH	DEPTH
YRA42	2134mm	1067mm	305mm
YRA60	2032mm	1524mm	305mm

Crossbar 20x6mm solid flat bar.  
 Scrollwork 10x3mm solid flat bar.



# General Information



## MEASURING

All metal range sizes refer to actual post to post openings and not the physical gate, fence or rail width; we have already allowed for the hinges etc. Wooden range gates are actual physical width.



## MADE-TO-MEASURE SPECIAL SIZES

A made to measure service is available for gates, railing and fence, where stated. Contact us with your details on our help line, fax, or email for a quotation. Standard finish is primed unless otherwise agreed.



## FITTINGS PACKS

Unless specified, all metal gates, fence and railings are supplied with a pack of screw-on/bolt-on fittings to fix to existing timber, brickwork and the steel posts listed. Screws and rawl bolts are not included in fitting packs.

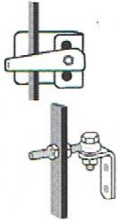

## GATE HANGING / LATCHING

We make every effort to ensure the holes in the pre-drilled holes in metal posts are accurate, however as metal the gates and fencing are mass produced there may be occasions that the fitting will have small gaps. This is due to the acceptable variation in the steel tolerances that we have no control over. If 100% accuracy is required then we recommend you purchase blank posts and drill to suit on site. Pre-drilled Posts are only for level ground and Blank Posts are for any ground conditions, particularly recommended for sloping ground conditions.

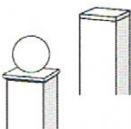

## POSTS

Due to the weight of the gates, care must be taken to ensure that the post or brickwork is strong enough to support them. Posts are supplied in two types, pre-drilled holes or blank without any pre drilled holes. Blank posts are better suited to varying ground levels. The top of the pre-drilled post may not be level with the top of the gate or fence. Height of ball top posts do not include the ball.



## PRIMED OR POWDER COATED ONLY RANGES

All metal products (unless stated) are supplied as standard either powder coated or primed in black and after fitting a further coat of good quality paint is required. We recommend that the paint should have high rust inhibiting properties. Regular inspection should take place to ensure the coating is not damaged to prevent the onset of rust. Rust is not considered a manufacture fault and as such does not constitute a warranty claim. Timber gates are pressure treated with Tanalith-E, a good general purpose wood preserver to help extend the life of the timber but the gates should still be regularly inspected and treated as required.



## ELECTRO GALVANISED & POWDER COATED FINISH

Most primed or only powder coated metal products have the optional better finish of being electro-galvanised for added corrosion resistance with a black powder coat finish. The coating is not a rust prevention guarantee. It is still the end customers responsibility to periodically paint / touch up any damage to the powder coating finish. Rusting is not considered a manufacturing fault and as such does not constitute a warranty claim. As these are stocked in lower quantity, they may take up to 28 working days to be delivered



## AVAILABILITY, DELIVERY AND RETURNS

£15.00 net carriage charge applies to all orders irrespective of the order size. Unless stated, most gates, fence and railing are available ex-stock 5-7 working days UK mainland delivery.

Out of Stock or Non Stocked and Made-to-Measure items can take up to 28 working days for UK mainland delivery. There may be a carriage surcharge for outer lying areas, Highlands, NI and Islands.

Returns must be requested in writing within 10 working days of receipt of the goods. There is a 25% re-stocking fee for unwanted returned goods. The costs of returning unwanted goods are for the buyers account.





# HOW TO MEASURE

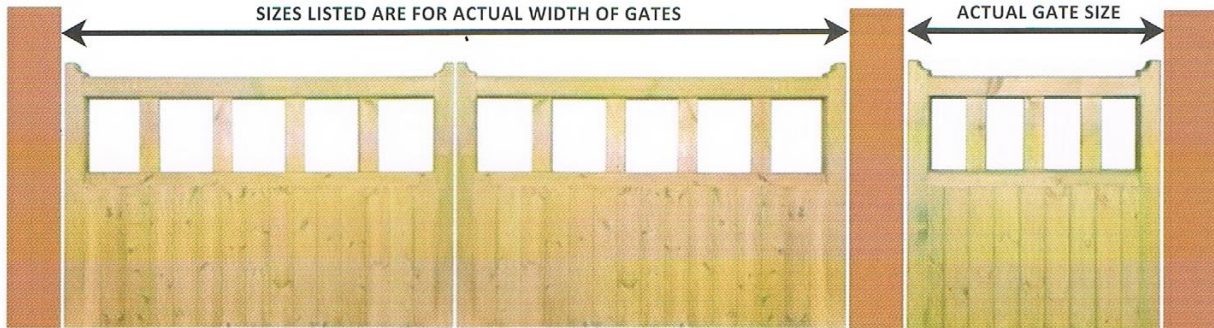

## Wooden Gates

If you choose one of our wooden gates, the width measurements stated are for the **actual size of the gates**. Allowances will have to be made for posts, fittings and clearance at the centre. Call the trade help line if you have any questions or need advice.

Heights quoted are for the actual height of the gate.

Fittings and accessories can be purchased separately.

All wooden gate sizes shown are nominal as wooden gates will shrink or expand depending on the temperature and the weather.

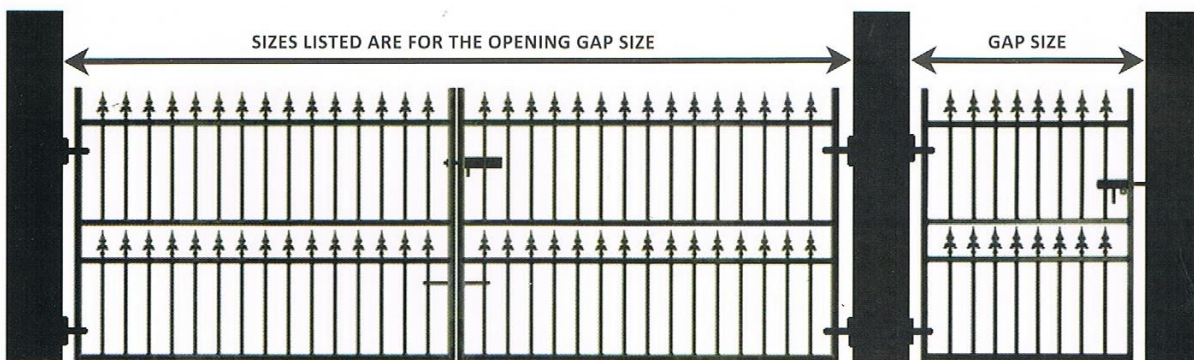

## Metal Gates & Railings

If you choose one of our metal gates or railings, the measurements stated are for the **TOTAL GAP between the posts / pillars / walls, not the actual gate/railing width size**. You do NOT need to make any allowances for the fittings gaps as we make all the necessary calculations for you. Call the trade help line if you have any questions or need advice.

If you already have wooden or steel posts, brick pillars or walls, simply measure the total distance between them.

Wall Fixing Posts and Packer Posts can help solve the problem of a non-standard opening.

Heights quoted are for the actual height of the gate.